

A photograph of industrial machinery, likely a mill or roller, with a sensor arm extending over a metal sheet. The sensor arm is black and has the 'procemex' logo on it. The background shows a factory setting with various pipes and structures.

procemex One Platform

Web Monitoring
&
Inspection System

procemex[®]

Future Proof & Backward Compatible

Procemex One Platform - Fully Integrated

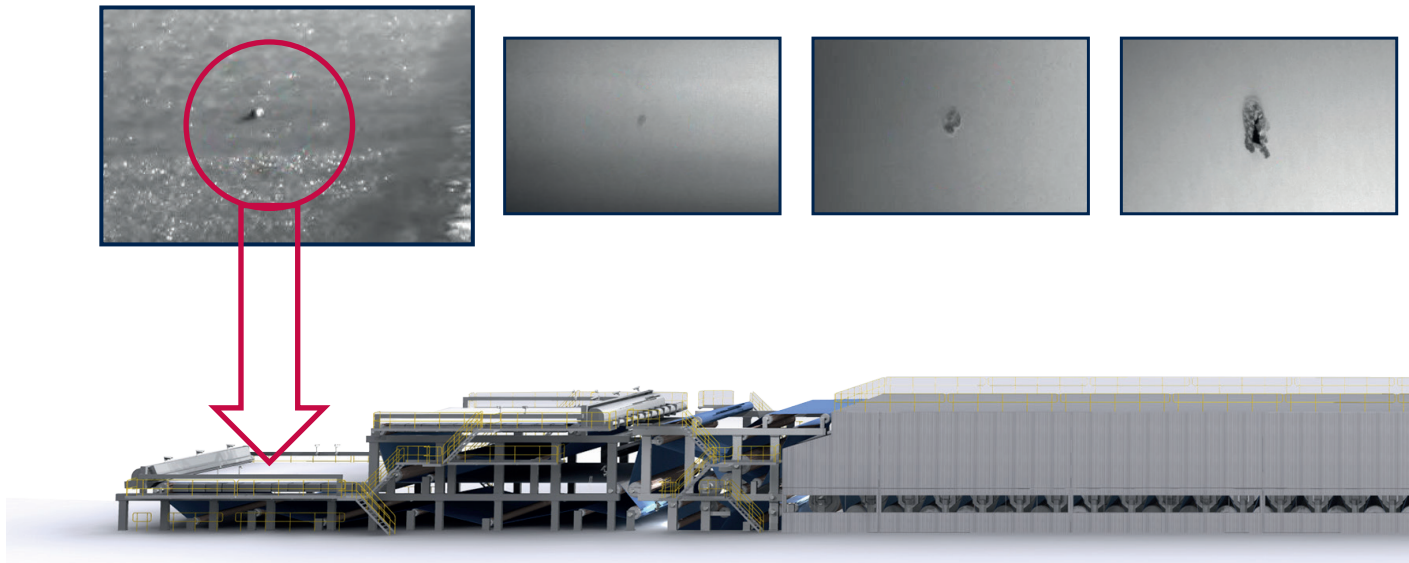

One Platform

Our customers have a common question: “What is the difference between buying the Procemex solution and buying web inspection and web monitoring systems based on different technologies?”

This is a good question, and has different answers to different groups, as it touches operators, production management, quality assurance, IT, maintenance and project engineers.

One Platform - One User Experience

The intuitive web monitoring & web inspection user interface is not designed for analyzing web breaks and paper defects separately. It has been designed to form one unified user interface, making it easy for operators to understand the inter-relations between web inspection and web monitoring and move flexibly between the ‘two systems’.

This makes it easy for operators to understand the real root causes for paper defects and web breaks created in the dryers, in the press, and in the forming section.

- One window into the inspection & monitoring world
- Pre-configurable paper defects activate upstream cameras
- Upstream camera viewing area define automatically which cameras are included in the same video
- Web inspection and web monitoring cameras synchronized with each other
- Upstream root cause video evidence is only one click away



One Platform for IT

As the Procemex Smart Cameras process the data already inside the cameras and send the results via TCP/IP Network to the server, there is need for only one server for the whole system. It manages the SQL database for storing and distributing data and communicates with 3rd party systems.

When there is only one computer for the whole system's data processing, that can contain over 200 cameras, this is beneficial, as it:

- Enables system virtualization by using Procemex server
- Enables system virtualization with preferred customer hardware and service
- Enables parallel server replication
- Enables easy backups

All Procemex systems delivered since 2002 are fully supported and compatible today.

ated Web Monitoring and Inspection

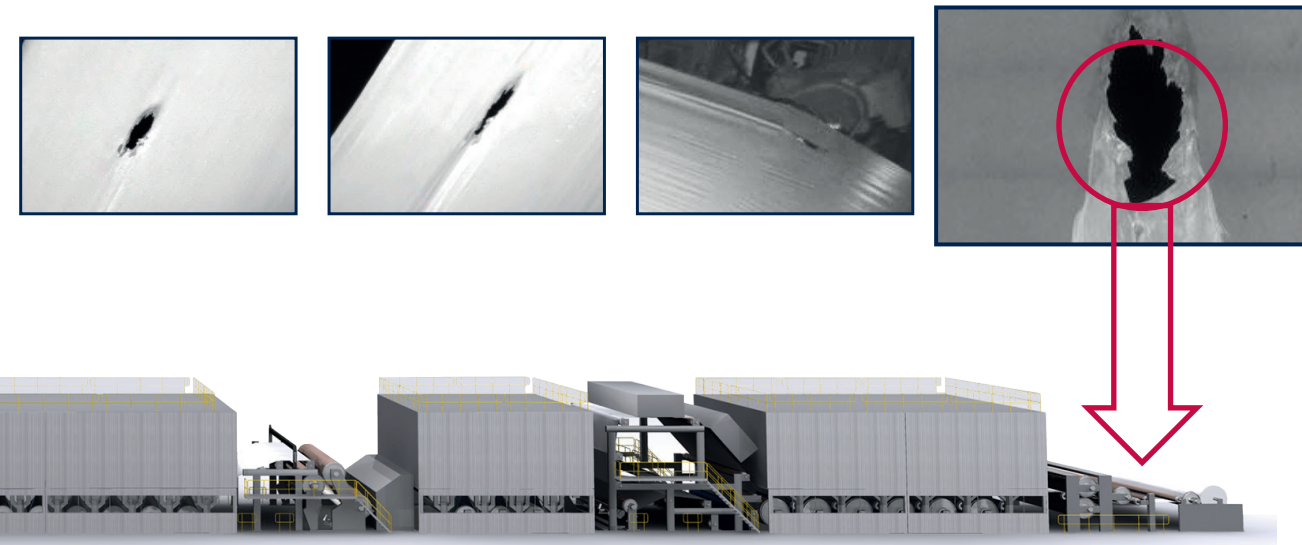

One Platform for Maintenance

In addition to the shared data storage infrastructure and user interfaces, it is also important that there is only one application software covering both web inspection and monitoring. This makes it easy for maintenance and application engineers, as everything is handled in one unified way and there is no need to learn two systems.

Web inspection and web monitoring also share the same lighting and smart matrix camera technology, eliminating multiple spare parts and extensive troubleshooting efforts.

One Platform for Support

When our customers need us, our project managers, field service engineers, remote service engineers and service teams can quickly provide support for both inspection and monitoring. One Platform allows our people to help you without application boundaries.

One Platform for Longer System Lifetime

By developing our own smart camera technology in Tampere, Finland, and continually pushing further the boundaries of camera performance, we have been able to go beyond the compatibility problems of fast turning computer and off-the-shelf camera world. It seems that the systems built on standard technology have today an average lifetime of 5 to 7 years due to component obsolescence from OEM hardware manufacturers and lack of compatibility in new components.

Procemex builds systems that are future proof and backward compatible. This is our promise to our customers, and it is one of our key values in smart camera development.

All our systems starting from 2002 are compatible and can be extended or upgraded.

Our Customer Commitment:
Future Proof and
Backward Compatible Systems



Web Inspection

Building defect detection on One Platform-architecture has elevated Procemex to the leading position in the global surface inspection and monitoring market.

The applications range today from coated box board to coated paper, magazine paper, newsprint, tissue and linerboard. There are no paper grades that Procemex OnePlatform Web Inspection can't cover.

Higher Level Defect Detection with Photographic Imaging Quality

- The unique Procemex Smart Camera Autosshutter-feature provides even exposure and illumination over multiple grades and shades of color. This enables fully automated grade settings even with hundreds of paper grades and color shades.
- Highest resolutions provide crystal clear images
- Powerful stroboscope lighting stops the web movement, eliminates motion blur and produces photographic image quality
- Procemex Smart Camera provides industry leading sensor light sensitivity and image bit depth

Powerful and Versatile Strobe Lighting

- Camera activates LED flashing and illuminates only during camera image exposure. With strobing, heat generation is reduced due to reduced LED illumination time
- One camera can make several independent measurements by commanding different LED light profiles to flash sequentially
- The utilization of a strobed lighting technologies allows long life of LED by elimination of heat generation.
- Strobe UV-light technology is available for 100% reliable oil detection



Different Detection Technologies

Transmission Web Inspection



Alternating Light Web Inspection



High Angle Reflection Web Inspection

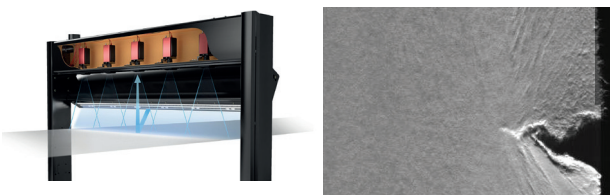

Low Angle Web Inspection

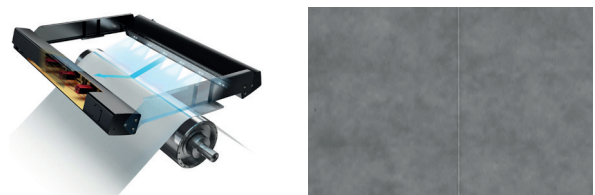

3D Defect Web Inspection

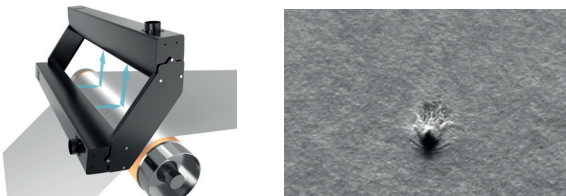

Side Light Web Inspection **US Pat. 11,128,808**
FI 128235



UV-Light Based Oil Inspection **US Pat. 10,955,347**



Special Algorithms for Subtle Defects



Classification

- Pre-classification inside smart camera allowing instantaneous classification for first level defects
- Real-time outputs from first level defects
- Post-classification beyond single inspection frame measurement utilizing all data available for the most accurate classification
- Alternating illumination provides more information for the post-classification engine, increasing the benefits of the Smart Camera technology
- Advanced AI Classification utilizing neural network algorithms

Multi-frame camera imaging providing higher quality images to the classification engine and increasing accuracy over antiquated line-scan technology.

Automatic Winder Target Control

Running winder with optimum efficiency; requires that winder operators know paper defect locations in advance. Based on accurate knowledge of the machine directional and cross directional defect location, operators can make educated decisions whether to keep full speed, slow down, crawl or stop the winder for patching the defect. This process can also be automatic.

- Ensure that winder is not forming a bottleneck for paper production
 - Remove defects to meet customer specifications
 - Winder and re-reeler defect stop accuracy achieved by bar coding paper edge at paper machine and by reading the code at the next production phase
- Rolls can be run again after winder at re-reeler in case it is necessary to remove defects and save rolls. As the bar code is at that phase already removed, it is necessary to crawl the roll to the first defect and let the system synchronize the rest of the defects automatically.

Features

- Enables automated re-reeler and winder stop features
- Increases production line throughput

General Web Inspection System Features

- On-line defect map, that is scrolling down automatically as the paper passes by
- Each defect also includes a short, user definable streaming video
- Digital zooming without limits
- Formation measurement
- TAPPI/ISO-dirt count capable
- Includes reel number and paper grade data import from 3rd party system by using OPC DA / OPC UA / REST protocols
- Dirt counter showing weight factor and number of defects per certain area
- Repeat defects, 100+ machine elements
- Trends 15min, 30min, 1h, 8h, 24h, weekly
- MD & CD profiles for different defects
- Report shift, weekly, monthly
- Reel report, reel number and length, which kind of defect, size, MD & CD location, defect count
- Defect map export by using SFTP / REST / ODBC protocols



- Code verification ensures marking readability
- Provides absolute sheet position regardless of slab-off and shrinkage
- Fast code reader cameras enable small code size and low ink usage, keeping environment clean
- Successful encoding up to 2000 m/min , 6500 ft/min
- Successful reading up to 3000 m/min, 9850 ft/min



Web Monitoring - Additional Eyes

Procemex Web Monitoring Cameras along the production lines provide additional eyes for operators and clarify what happened during the milliseconds when a web break took place. With enough cameras in the right locations, the cameras provide required accuracy and clarity about the root cause of an event. Additionally, integration with Web Inspection reduces downtime. The main obstacles for better machine efficiency are typically either number of cameras, or inferior image quality.

Inferior image quality is related to the following factors:

- The camera and light cleaning system
- Low camera shutter speed not capable of stopping the sheet movement
- Lens out of focus
- Low camera resolution
- Weak light source
- Light not synchronized with ambient light (uneven frame rate or missing sync)

Camera & Light Cleaning

Since 1994, Procemex has been gathering knowledge in various cleaning methods. Today the work is focused on perfecting pinhole camera cleaning technology and image quality. As most of the cameras are located in the forming and press section, it is clear that keeping cameras and lights clean in a harsh environment is important.

Lights are typically kept clean by applying a thin water layer on top of the protection window. The cleaning water also takes care of light cooling.



Procemex
Pinhole
Camera

Maintenance

The most typical reason for poor image quality is lack of maintenance. With a dirty camera and light windows, the camera shutter speed is often reduced too much. This makes the real time image look good, but the camera can't stop paper web movement and recorded videos get blurred.

Web Monitoring field equipment should be under maintenance routines. In case help is needed, Procemex offers various service elements, starting from remote reports and ending to servicing the equipment under the service agreement.



Camera Resolution

Camera resolution tends to grow continuously and is with today's cameras more important than the frame rate. In practice, it is often difficult to utilize the highest resolution available, because the system is already using its full data transfer capacity. This is the most typical reason pushing customers to change their system. Today this is especially relevant, as 1 GigE network supports only 2,1 MPix resolution with 50 fps and 1,9 MPix with 60 fps. Resolutions above that are not possible without reducing frame rate.

Procemex camera resolution is not limited, as the camera processes data inside its own shell and doesn't send it to be processed elsewhere. When the video is completed inside the camera, it sends the file over network to the server. This architectural difference enables Procemex to take the next step in the direction of 12 MPix camera resolution.

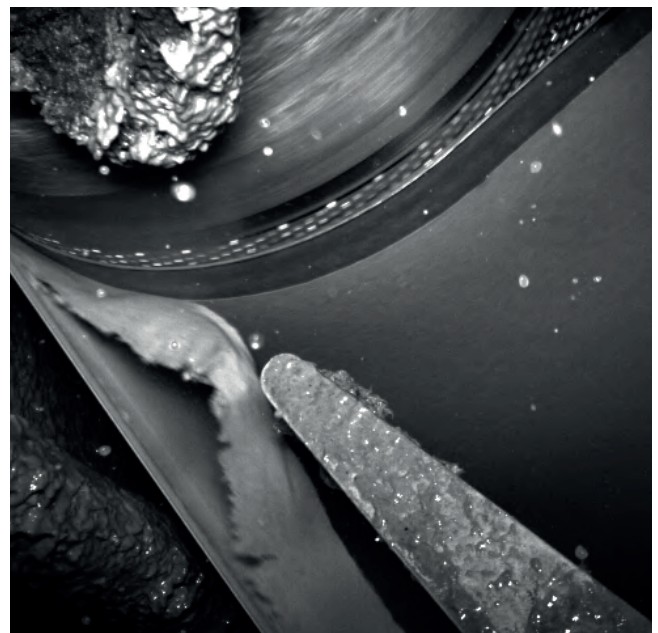

Procemex
Smart
Cameras



Web Monitoring – Lights

Procemex uses LED strobe lights that can be synchronized with AC sync with ambient illumination to prevent a fade in-fade out effect from happening.

The latest LED technology is enhanced with custom designed focusing lenses, and optimized use of power. Procemex ECO LED Light has indirect cooling unit, that can use instrument air or water. The benefit of indirect cooling is that there is no instrument air inside the light, and that there is no possibility for over-pressurizing the housing and causing the protection window to explode.



ProClean Pinhole Cameras stay clean in every machine position



Installation date

After 6 months

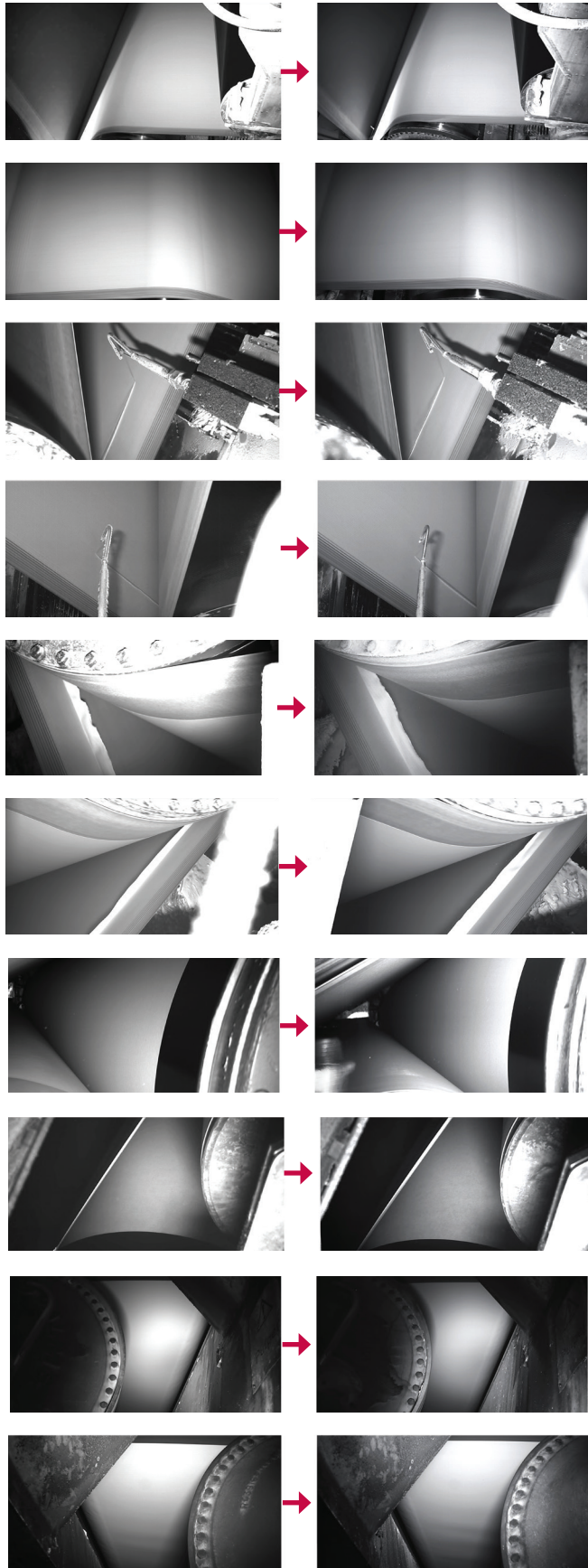

Installation date

After 6 months

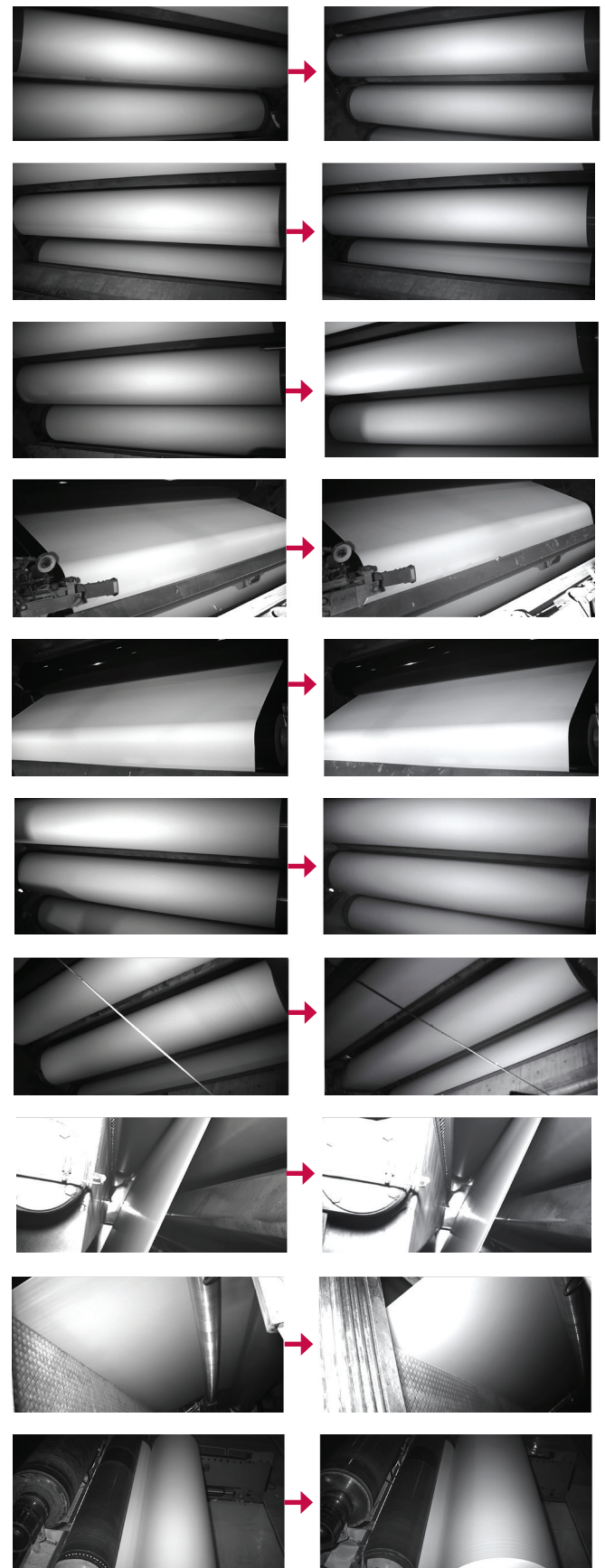



Full Set of Tools for Results

Procemex Web Monitoring System assists operators in handling all production quality, and production efficiency items with the aid of a set of computer supported analysis tools.

- Full width visibility at wet end
- Superior resolution with 2,1 and 12 MPix Technology
- Unique Wet End Pinhole Frame covers full machine width
- Operators focus troubleshooting in right areas
- Paper and fabrics related issues covered
- Defects and root causes identified quickly through elimination method
- More efficient process
- Less paper quality issues
- Reduced reaction times

General Web Monitoring System Features

The Web Monitoring Software controls all functions of the system. With an intuitive graphical user interface, the operator selects a preferred real time monitoring mode between quad and single images, selects which events (breaks, web defects and image analysis) to analyze and asks the expert database to advise in problem solving.

Features:

- Selection of real time display mode (independently at dry end and at wet end if necessary)
- Breaks, defects, image analysis and other events are selected in event selection page with one click
- On the event selection page the system displays automatically created thumbnail images from all camera positions to simplify and make analysis faster
- Event analysis page includes easy-to-use image controlling functions both with video recorder type buttons and with slide bar
- Cameras are synchronized with each other within the accuracy of two frames
- Event analysis page includes special image change measurement trending
- Bookmarks can be tagged with images and image trends, and video clips can be edited as needed
- Digital zooming without limits
- Each camera features Region of Interest (ROI)
- The system recognizes image changes within each video clip and guides the operator
- Expert database to advise about problematic cases

Pickup Web Inspection - A Superior Tool for finding Root Causes of Web Breaks

US Pat 10,739,581 EP 2796616

With the traditional web monitoring cameras located on the sides of the paper web in the press section, you can view only those defects, that are located close to the paper edges. Should the defect be in the middle of the web, the web monitoring cameras aren't your best tools for finding the defect. And even if the defect was located close to the paper web edges, the traditional web monitoring cameras many times are too dirty to provide sharp enough images that would help you.

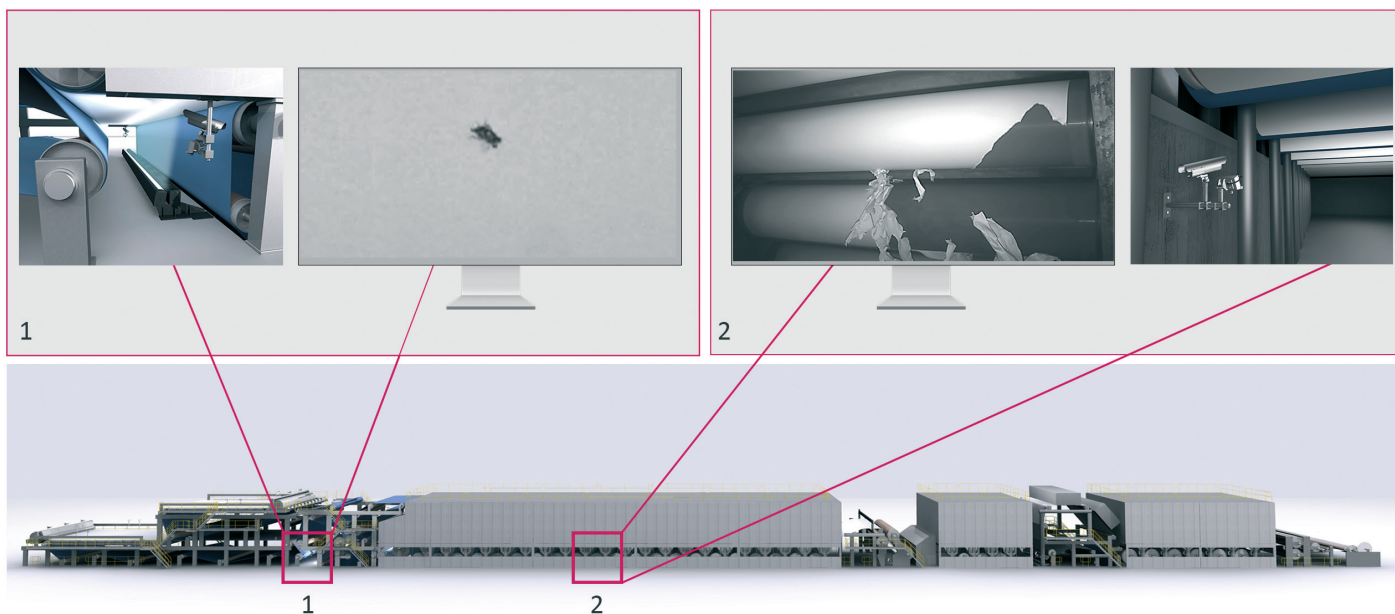

1. Pick-up web inspection frame and a defect image from pick-up section (insect trapped on paper web).
2. Web break caused by insect, defect image from press section.

This is why pick-up web inspection is a game-changer. A web inspection frame located in the paper machine's pick-up point captures the defect images sharply and from the entire width of the paper web. And the images taken are crystal sharp due to the revolutionary Procemex ProClean technology.

The pick-up web inspection utilizes pinhole cleaning technology where the air is purged through a 5 mm hole to keep the camera lens continuously clean in a dedicated inspection frame. This technology keeps all the cameras inside the frame clean 24/7 assuring, that not a single spot on the paper web doesn't get left detected.

But why is the pick-up location such a game changer in defect detection? That is because it makes it possible to limit the root cause search to one paper machine section.

If the defect is seen in the images captured by the pick-up web inspection, it gives a clear signal, that the search can be targeted to the forming section.

On the contrary, if the defect is not seen by the pick-up web inspection, the root cause that caused the paper web break must be situated after the pick-up in the press section.

Based on our experience, the web inspection under pick-up offers better understanding of where to focus machine cleaning actions in order to improve runnability. This information helps operators save valuable time, and to target the root cause search actions in the right areas. In many cases, the defects are caused by dirt that is built up in the paper machine. To avoid web breaks taking place again for the same reason, these machine parts need to be cleaned more often or more carefully in the future.

The patented Procemex Pick-up Web Inspection System is available for full width & high-speed paper machines.

User Interface

Procemex OnePlatform ranges from small camera projects up to the greatest production lines in the world, covered by several hundred cameras.



Web Monitoring & Inspection Features

With an intuitive graphical user interface on dual screen, the operator selects whether he/she wants to analyze the root cause for a web break, view a paper defect and decide on follow-up actions, or to ask the expert database to advise in problem solving.

- Scrolling defect map with customer selected defect symbols displayed frame by frame or in overlaid mode
- Defect data displayed in the bottom and as tool tip on defect map
- Reel number and paper grade imported and displayed
- Possible to zoom in or zoom out defect map to cover several paper reels at the same time
- Activate/deactivate defect classes per each viewing location
- Planned customer roll set and defect density data overlaid on defect map
- Actual vs sold roll quality indicated by colored customer rolls
- Code verifying at paper machine with indication on defect map
- Trends 15min, 30min, 1h, 8h, 24h, weekly
- Profiles for different defects
- Report shift, weekly, monthly
- Reel report, reel number and length, which kind of fault, size, MD & CD location, fault count
- Periodic/repeat defects with machine elements data
- Upstream monitoring camera access with red button at the side of defect map
- Web Inspection camera displayed at monitoring camera list fully synchronized
- Selection of real time display mode (independently at dry end and at wet end if necessary)

”>1000 delivered systems and around 20.000 Smart Cameras delivered for pulp/paper/print manufacturing”

- Web monitoring
- Web inspection
- Automatic winder control
- Formation measurement
- On-line dirt counting

- Real time images
- Long time recording
- Flying splice analysis
- Machine vision applications

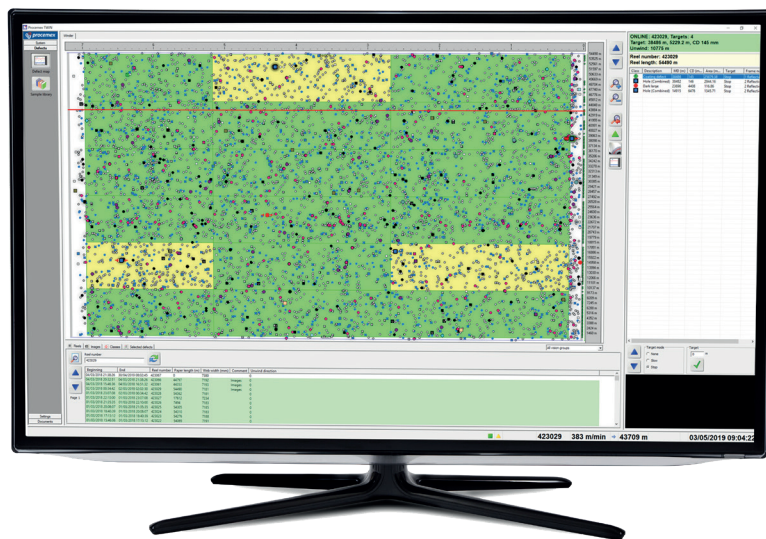

- Breaks, defect root causes and other events selected in event selection page with one click
- On event selection page the system displays automatically created thumbnail images from all camera positions to simplify and make analysis faster
- Event analysis page includes easy-to-use image controlling functions both with video recorder type buttons and with slide bar
- All cameras are synchronized with each other within the accuracy of two frames
- Bookmarks can be tagged with images and image trends, and video clips can be edited as needed
- Digital zooming without limits
- Each camera features Region of Interest (ROI)
- The System recognizes image changes within each video clip and guides operator
- Expert database to advise about problematic cases

Automatic Winder Target Control Features

With an intuitive graphical user interface, the winder/re-reeler operator selects which defects call for some action in form of slowing down the machine or rejecting the defect.

- Automatic/manual reel loading
- Defect map with customer roll cut and set positions
- Current position visualized with moving red line
- Selected slow down or stop targets indicated on defect map
- Defect image and data displayed at the bottom of user interface
- Code marking sync marks displayed at the side of defect map
- Code mark quality symbol, machine speed and width displayed at bottom of user interface

OnePlatform Vision Applications

A comprehensive range of AI-enhanced analysis applications take web inspection and web monitoring to a completely new level. They improve production flow and product quality, manufacturing efficiency and operator safety.

Applications – Paper & Board Industry

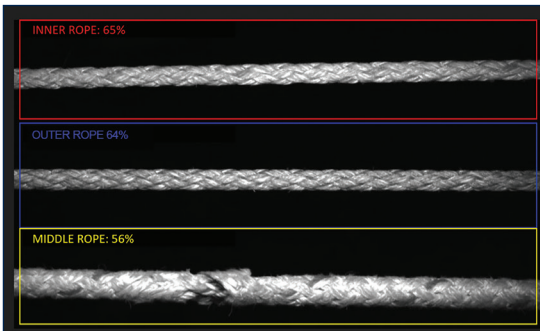

AI enhanced Threading Rope Monitoring

The Automatic Threading Rope Monitoring examines the condition of threading ropes and their expected lifetime 24/7 helping to prevent serious damages and expensive unplanned production shutdowns. Rope breaks can also form a safety hazard and cause severe damage to people and equipment.

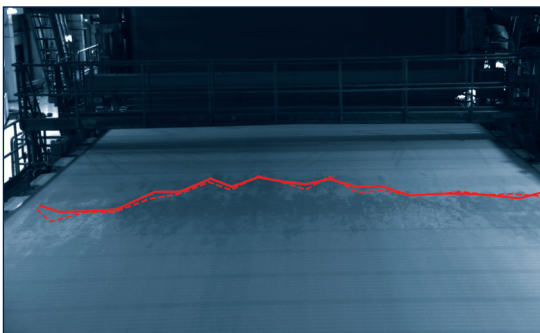

AI Enhanced Dry Line Analysis

The innovative camera-based Dry Line Analysis helps to identify paper profile problems accurately. With the help of smart Dry Line Analysis the operators can keep the dry line in its optimal place leading to enhanced product quality, reduced use of raw materials and energy savings.



Paper Roll Eccentricity Inspection

Automatic optical measurement of Paper Roll ovality, eccentricity, and other dimensional features helps to assess product quality and ensure worker safety. Eccentricity measures how well the core is centered in the roll. If the core center is off from the roll center by more than a few millimeters, the roll may cause damage or create a safety hazard when unwound at the customer site.

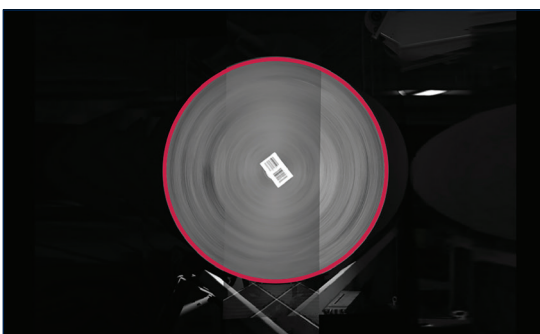

Paper Roll Label Inspection

The Procemex Roll Label Inspection Application ensures consistent quality in paper roll labeling in high-speed packaging and labeling lines. It captures images of the packaging line and notifies operator of any anomalies. The application verifies that the label is correctly attached, and all required information is present. Any critical faults are immediately reported to the control system.

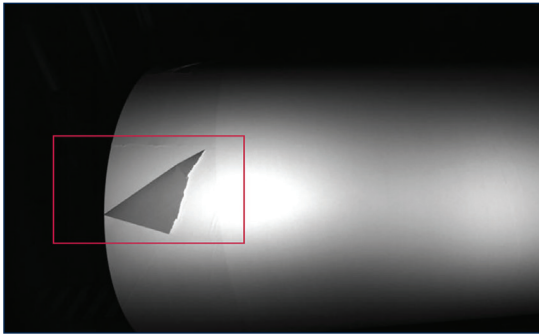

Roll Wrapping Analysis

Roll wrap quality inspection ensures the roll is properly protected, free of defects and provides traceability with documentation. It generates an "as shipped" quality report and image record for each roll. Cameras analyze wrapping and headers for defects, and in case of critical defects, trigger an output to the control system.

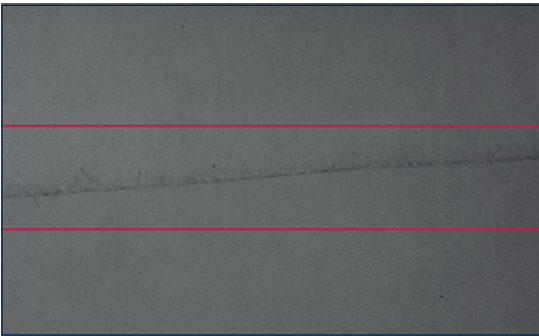

Paper Roll Tail Position Inspection

Tail position identification reduces wrapping material and time. By placing the roll with the tail just past the starting point of the wrap, wrapping can be reduced by up to 50%. A camera detects the tail, allowing for precise positioning and saving up to 30 seconds per roll change.

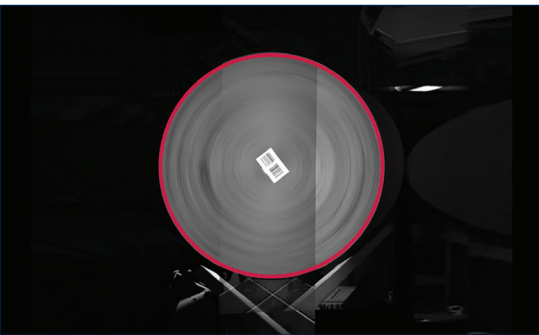

Paper Roll Roundness Inspection

Procemex machine vision application for roll roundness inspection is necessary for efficient operation and optimum paper quality. Out-of-round rolls will cause vibrations and can even damage customers unwind equipment.

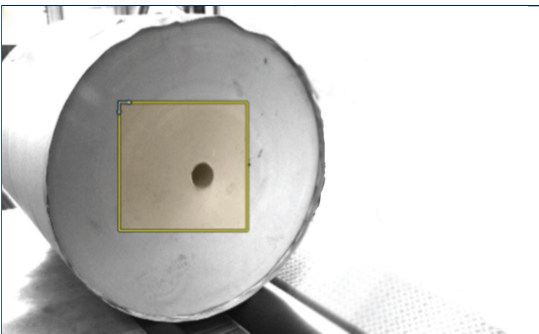

Paper Roll Header Presence Inspection

Roll header detection using cameras reduces the risk of damage during packaging and transportation. Cameras capture images of both roll ends after wrapping, and check for the presence of an inner header. If missing, the control system is signaled, and the roll can be re-wrapped or have the inner header manually placed before the outer header is glued.

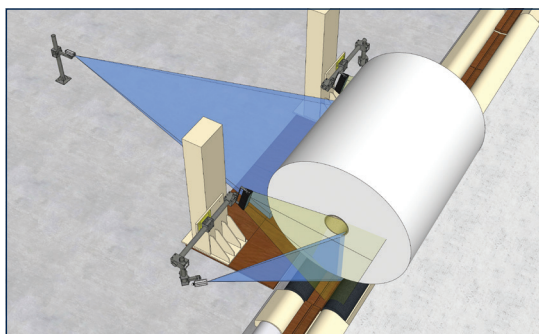

AI enhanced Paper Roll Surface Inspection

AI-enhanced Roll Surface Inspection detects deviations from the roll before wrapping. It analyses the ends of the roll and the surface of the roll. Roll surface inspection detects the tears, bumps on the ends, dirt and scratches. Deviations are identified with a classifier that identifies and separates labels, tapes and other parts of the roll from the possible defects.

OnePlatform Vision Applications

Applications – Pulp Industry



Pulp Bale Wire Control

The de-wiring device may sometimes fail to detect some wires, leaving them uncut and not disposed of properly. To address this issue, the Procemex Pulp Bale Wire Control application is designed to detect the presence of wires and alert in case of any non-compliance.

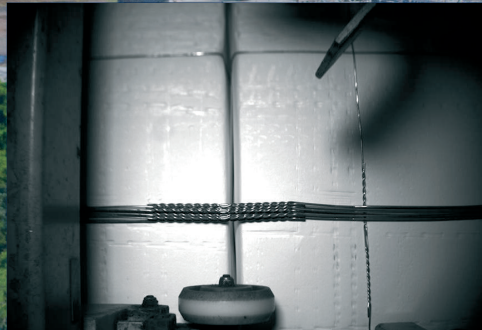

Pulp Bale Wire Twist

Ensuring the safety of every bundle of bales is crucial. To achieve this, Procemex camera inspects the bale from below. The Procemex Pulp Bale Wire Twist application then verifies the quality of the wire twist used to tie the bundle. Any defective twists are automatically displayed on the operator's monitor. The analyzed twists are also stored in the operator's station for future reference.



Pulp Bale Wire Tension

Pulp Bale Wire Tension is critical. Procemex camera system checks the wrapping wires for proper tension to avoid bale compression. The system gives an alert if any of the wires are too tight or loose.

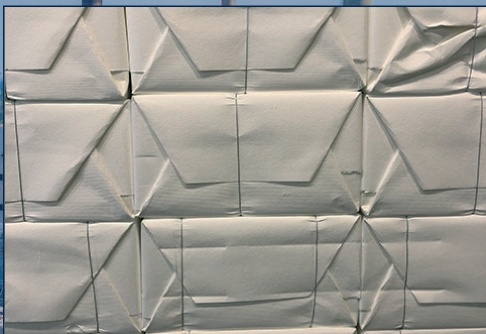

Pulp Bale Wire Count

Wire breakdown of a pulp bale, can cause hazardous situations. Procemex Pulp Bale Wire Count application provides higher operator and machine safety for working conditions where it is difficult to recognize the elements of danger. The application checks the positioning and counting of bale wires and compares the number of wires required. If the wire count falls short, an alarm is triggered to alert the operators of the potential danger.

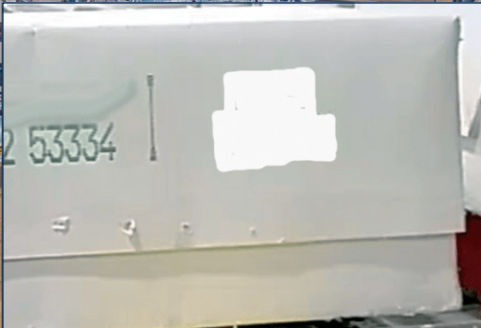

Pulp Bale Label Quality and Accuracy Inspection

The application automates the identification of pulp bale numbers, reducing manual work. Cameras are used to check that the printed information matches with the information of the control system, including the correct grade code, barcode, printed batch number and logo. This application is typically combined with label quality application and can be integrated into the same Procemex cameras.



Pulp Dirt Count Inspection

Procemex's Pulp Dirt Count Inspection is a vision application that measures dark and colored particles in liquified pulp. The application helps detect undigested particles that can cause quality issues in various parts of the paper machine. These particles can be from frayed fibers or plastic contaminants. By using machine vision, the pulp can be flushed before production or reprocessed.

Service & Support

Focus on high productivity, reliability and performance

To ensure the reliability of your machines and processes and maintain good product quality, it is essential to keep your machine's vision system at its optimal level throughout its entire lifecycle. We strive to be your partner in continuous development by providing you with the latest advancements in vision systems.

We offer upgrades for your existing camera system, to optimize its performance. Our full-scale service portfolio includes everything from 24/7 connected remote services to preventive maintenance and smart spare parts services.



Service Agreement

Regular scheduling and proactive service can decrease maintenance costs, optimize production quality, and minimize web breaks. The Service Agreement is customized to meet each mill's individual needs. You can select services from our modules to ensure smooth system performance and modify the agreement as needed. Our collaboration through the Service Agreement ensures continuous system performance improvement.



Remote Services

We offer Remote Services for web inspection and monitoring systems to resolve issues from anywhere, anytime. Our team ensures high-performance levels and quick response times. Over 90% of issues can be resolved remotely. We provide comprehensive reviews and suggestions to enhance system performance. Count on us for timely support, available 24/7.



Spare Parts & Repair services

Procemex provides readily available OEM spare parts with the right software and setups, along with repair services for cameras, lights, and PCs. We maintain comprehensive spare parts inventories globally and can set up one at your site for critical parts.



System Modernizations & Virtualization

Upgrade your system with our modernization packages for better performance and extended lifecycle. Enjoy flexible and cost-effective upgrades in smaller steps.

To ensure a fast recovery from unexpected situations, we can have your existing system virtualized resulting in improved data security and reduced downtime.

We are committed to supporting your vision system's best performance and optimized maintenance throughout its lifecycle.



System Security & Software Updates

Annual software updates improve system performance, maximize its lifespan, and offer new features with improved data security. We plan and execute updates effectively and systematically with a service agreement, ensuring smooth system operation. Our data and system security services provide secure data backups, ensuring fast and reliable system start-up in case of problems or system failure.



Onsite Services

With our Onsite Services, you can ensure maximum reliability and optimal performance of your vision systems. We offer systematic and continuous system audits, along with well-scheduled onsite maintenance services, to guarantee a reliable operation of the paper machine's vision system. This, in turn, enables you to optimize the entire papermaking process, ensuring its smooth and efficient functioning.



Training

The effectiveness of a Web Inspection and Web Monitoring system relies heavily on the operators utilizing it. Our goal is to ensure that you maximize your investment by providing your operators with the necessary skills to achieve success. We offer a diverse range of operator training programs tailored to your specific needs.



System Extensions

We develop future-proof systems that are also backward compatible. Our systems can adapt and extend easily to meet changing demands, enabling significant cost savings without investing in a new system. With our System Extensions, you can enhance your current Procemex WMS/WIS system with new functionalities. Our hardware and software are fully compatible with our older systems and can be customized to meet your production requirements.

procemex®

Future Proof
&
Backward Compatible



info@procemex.com

www.procemex.com

Procemex Oy Ltd
Headquarters
Manufacturing,
Sales & Service

Appiukontie 10
40530 Jyväskylä
Finland
Tel. +358 14 3372 111

Procemex Oy Ltd
Smart Camera
Excellence Center

Tietohallinnonkatu 15 A
33840 Tampere
Finland
Tel. +358 14 337 2111

BRANCH OFFICES

Procemex Inc.
777 Lowndes Hill Rd.
Building 3, Suite 325
Greenville, SC 29607
U.S.A.
Tel. +1 (864) 720-1510

Procemex GmbH
Neuwieder Straße 30b
D-56269 Dierdorf
GERMANY
Tel. +49 2689 972 6860

Procemex Japan Ltd.
Fumiei bldg.
3F, 3-18-36 Minami Ikebukuro
Toshimaku, Tokyo 171-0022,
JAPAN
Tel. +81 3 6820 2109